

VARIATIONS | 2020

COLOUR MADE BLACK & WHITE



Simply, our colours & woodgrain options **available ex-stock**

95%

of foiled sales are from stock

27

colour combinations

14

colours available ex-stock

5

weeks lead time typically
on made to order colours



imagine



Contents

Introduction.....	02-05
VEKA M70	6-7
VEKA Matrix FS.....	8-9
Halo System 10.....	10-11
Halo Rustique	12-13
VEKA & Halo FlushSash	14-15
Imagine Vertical Slider.....	16-17
VEKA & Halo Fully Reversible.....	18-19
Imagine Bi-Fold Door.....	20-21
Imagine Patio Door.....	22-23
VEKA & Halo Composite Door.....	24-25
VEKA/Halo Ancillaries.....	26-27
Reinforcement Guidelines & Notes	28-29
Notes.....	30-31

Colour made black and white

The demand for coloured profile presents a huge opportunity, which is why we've made it easier for you to order it. To put it simply, all of the colours in this brochure are ex-stock, sharing the same lead time as our standard profile. We stock the colours you sell – 27 colour combinations from a palette of 14 colours. We've shown the colour combinations available for each product range in the tables throughout. So, you don't have to go wading through a big book of swatches, it's all right here in one place. You can't get simpler than that.

This brochure is really easy to use, simply flick to the system you need using the contents and then you'll see all the colours available for that system right next to the colour combination table and the lamination chart – everything you need, all in one place.

Colour has always played an important role in architecture. More than a simple decorating choice, it can influence opinion, stir emotion and communicate a style choice. Colour is now as accessible when choosing windows and doors as hardware, which is why we've seen such a rise in demand for laminated profile. In fact, it now makes up 40% of total sales at VEKA UK.

We're predicting that the demand is going to keep growing, as people look to replace their windows and doors long before they've reached their end of life, simply because they want to update the look of their property. We're seeing this trend across residential, commercial and public sectors and we are investing millions in the manufacture of laminated profile, to continue to give you the best product and service in the industry.



95% of our colour sales are available ex-stock, but the Variations colour offer also includes a wider selection of less popular colours which can be requested made to order, typically with a 5-week lead time. Ask us for more information or a swatch book.

Typical Casement Window Lamination Chart

Foiled one side refers to the external face of sashes used in their normal manner.



For ordering purposes
A = non bead face

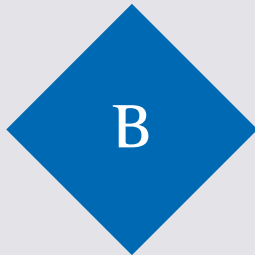

For ordering purposes
B = bead face*

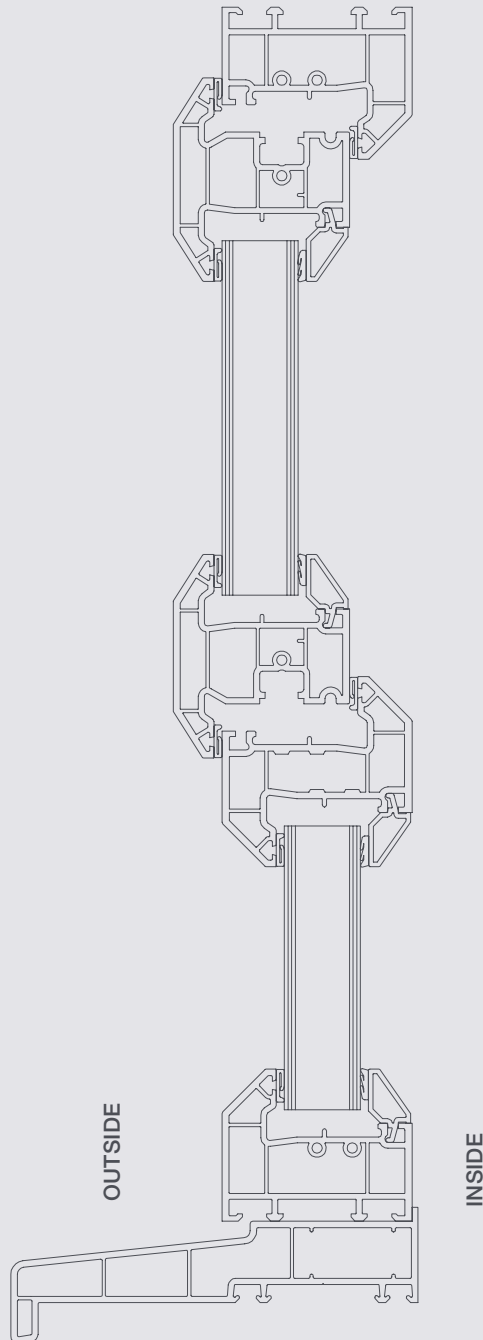

*In normal circumstances B is the inside face

For more information or to order a swatch book [contact us on 01282 716611](tel:01282716611), email salesenquiry@veka.com or visit www.veka.co.uk



VEKA M70 | Ex-Stock Colour Availability



Colour	Sides	Base	Ref	RAL Colour
Agate Grey	1	White	Agte	7038
Anthracite Grey	1	White	Anth	7016
Anthracite Grey	2	White	Anth	7016
Anthracite Grey Smooth	1	White	Anth#	7016
Anthracite Grey Smooth	2	White	Anth#	7016
Basalt Grey	1	White	Bslt	7012
Beck Brown	1	White	Bck	8022
Beck Brown	2	Brown	Bck	8022
Chartwell Green	1	White	CGrn	-
Cream	1	White	Crem	9001
Golden Oak	1	White	GOak	8001
Golden Oak	2	Caramel*	GOak	8001
Pebble Grey	1	White	Pbbl	7032
Rosewood	1	White	Rose	8015
Rosewood	2	Brown	Rose	8015
Silver Grey	1	White	Silv	7001
White	1	White	Whte	9010
White	2	White	Whte	9010

*Caramel base will be discontinued on all products from September 2020. From June 2020 Brown stock will be available to enable a smooth transition from Caramel.



With its clean bevelled design M70 offers the contemporary look that consumers demand.

With slimmer sightlines and leading thermal performance, M70 offers an alternative to aluminium and timber with the advanced performance associated with PVCu. This 70mm fully integrated multi-chambered system includes steel reinforcement for additional durability, security and thermal efficiency.

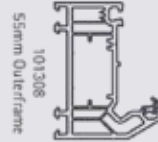

101308
55mm Outerframe

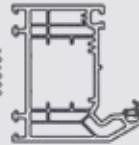

101309
67mm Outerframe

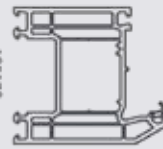

105176
80mm Outerframe
(* See chart page 20 for Bi-fold colour options)



102297
89mm T Mullion

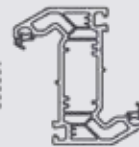

102298
89mm Z Mullion

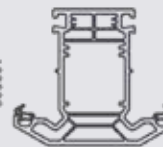

102299
82mm T Mullion

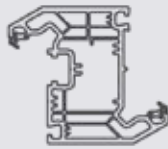

103364
82mm Hi N Turn Sash

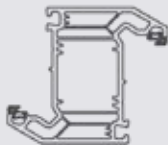

102296
82mm Z Mullion



103365
76mm Casement Sash/T Mullion

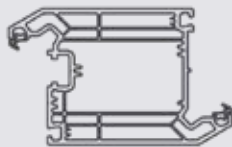

103366
115mm Open In Door Sash/Z Midrail

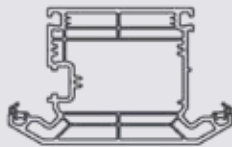

103367
115mm Open Out Door Sash/T Midrail

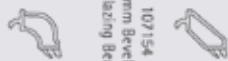

107154
28mm Bevelled Glazing Bead



107153
28mm Sculptured Glazing Bead



VEKA Matrix Fully Sculptured | Ex-Stock Colour Availability

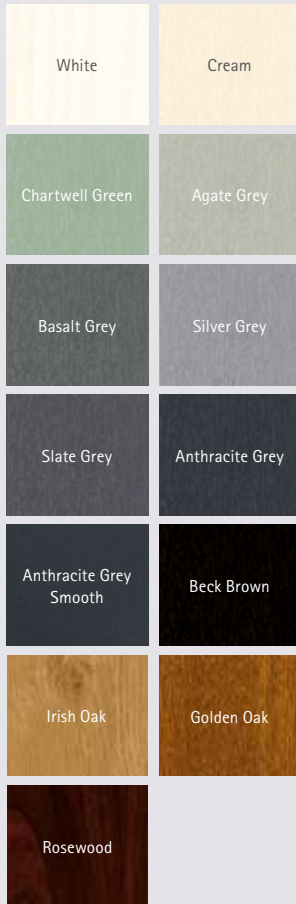

Colour	Sides	Base	Ref	RAL Colour
Agate Grey	1	White	Agte	7038
Anthracite Grey	1	White	Anth	7016
Anthracite Grey	2	White	Anth	7016
Anthracite Grey Smooth	1	White	Anth#	7016
Anthracite Grey Smooth	2	White	Anth#	7016
Basalt Grey	1	White	Bslt	7012
Beck Brown	1	White	Bleck	8022
Beck Brown	2	Brown	Bleck	8022
Chartwell Green	1	White	CGrn	-
Cream	1	White	Crem	9001
Cream	2	White	Crem	9001
Golden Oak	1	White	GOak	8001
Golden Oak	2	Caramel*	GOak	8001
Irish Oak	1	White	IOak	1011
Irish Oak	2	Caramel*	IOak	1011
Rosewood	1	White	Rose	8015
Rosewood	2	Brown	Rose	8015
Silver Grey	1	White	Silv	7001
Slate Grey	1	White	Slte	7015
White	2	White	White	9010

*Caramel base will be discontinued on all products from September 2020. From June 2020 Brown stock will be available to enable a smooth transition from Caramel.



The Matrix Fully Sculptured system was designed to replicate traditional aesthetics and feel of quality timber frames with the additional performance benefits of PVCu.

With its soft, rounded appearance this 70mm fully integrated multi-chambered system includes steel reinforcement for advanced durability, security and thermal performance.

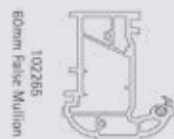
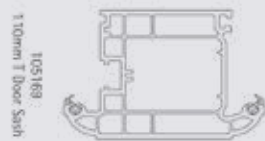
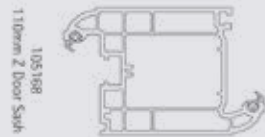
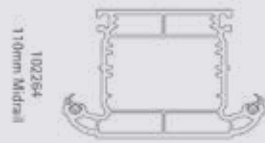
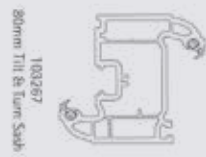
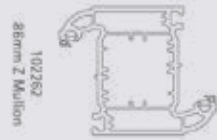

107155
28mm Sculptured
Glazing Bead

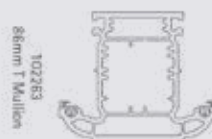
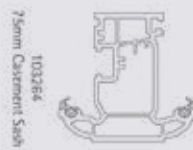
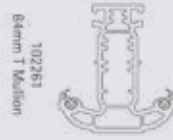
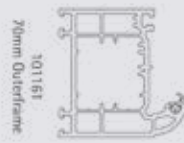
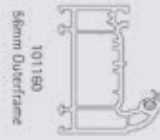



Colour	Sides	Base	Ref	RAL Colour
Agate Grey	1	White	Agte	7038
Agate Grey	2	White	Agte	7038
Agate Grey / White	2	White	Agte/White	7038/9010
Anthracite Grey	1	White	Anth	7016
Anthracite Grey	2	White	Anth	7016
Anthracite Grey/White	2	White	Anth/White	7016/9010
Anthracite Grey Smooth	1	White	Anth#	7016
Anthracite Grey Smooth	2	White	Anth#	7016
Anthracite Grey Smooth / White	2	White	Anth#/White	7016/9010
Basalt Grey	1	White	Bslt	7012
Beck Brown	1	White	Bck	8022
Beck Brown	2	Brown	Bck	8022
Chartwell Green	1	White	CGrn	-
Cream	1	White	Crem	9001
Cream	2	White	Crem	9001
Golden Oak	1	White	GOak	8001
Golden Oak	2	Caramel*	GOak	8001
Irish Oak	1	White	IOak	1011
Irish Oak	2	Caramel*	IOak	1011
Pebble Grey	1	White	Pbbl	7032
Pebble Grey/White	2	White	Pbbl/White	7032/9010
Rosewood	1	White	Rose	8015
Rosewood	2	Brown	Rose	8015
Silver Grey	1	White	Silv	7001
Slate Grey	1	White	Slte	7015
White	1	White	Whte	9010
White	2	White	Whte	9010

*Caramel base will be discontinued on all products from September 2020. From June 2020 Brown stock will be available to enable a smooth transition from Caramel.



Offering complete versatility with a clean, contemporary appearance System 10 is a fully integrated 70mm system featuring a modern bevelled design.

This technically advanced multi-chambered system includes steel reinforcement for advanced performance and added security and thermal benefits. The suite can be integrated with the Rustique 70mm sculptured system.

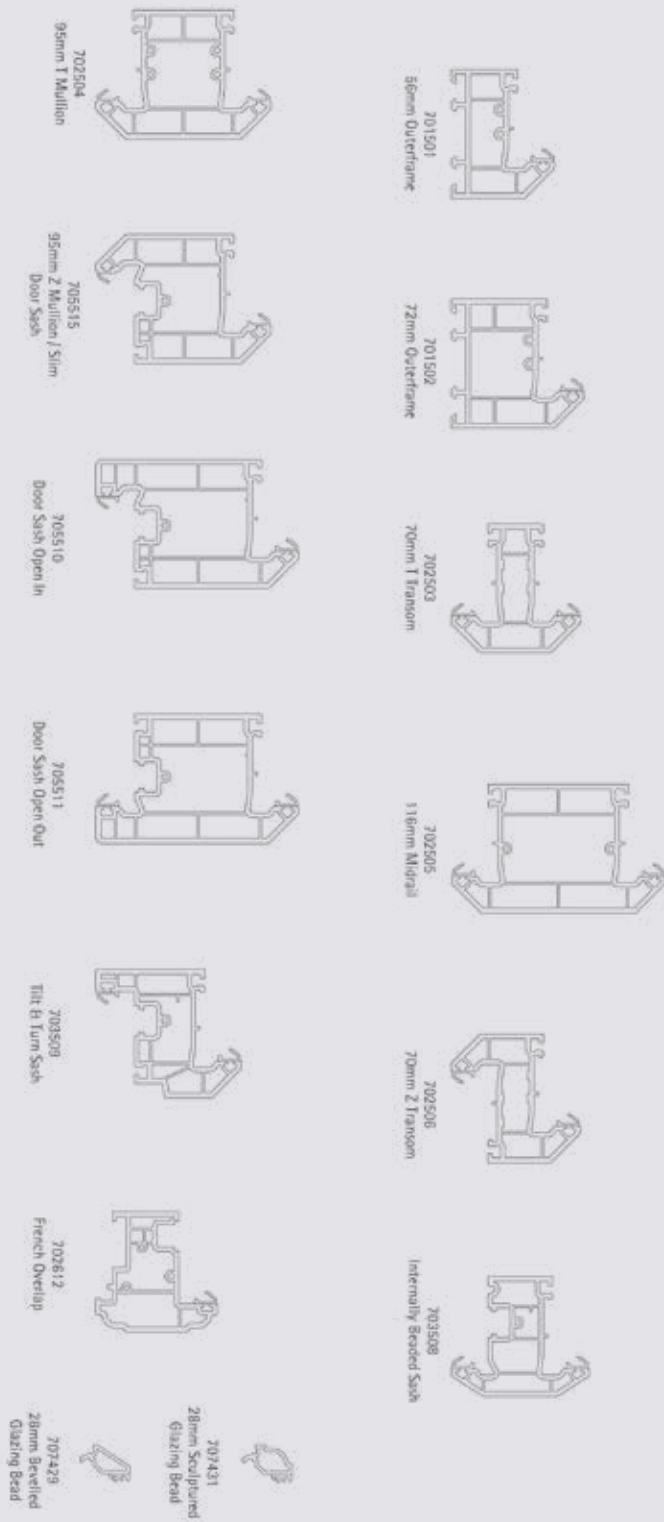











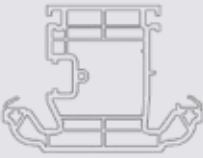

Colour	Sides	Base	Ref	RAL Colour
Agate Grey	1	White	Agte	7038
Agate Grey	2	White	Agte	7038
Agate Grey / White	2	White	Agte/White	7038/9010
Anthracite Grey	1	White	Anth	7016
Anthracite Grey	2	White	Anth	7016
Anthracite Grey/White	2	White	Anth/White	7016/9010
Anthracite Grey Smooth	1	White	Anth#	7016
Anthracite Grey Smooth	2	White	Anth#	7016
Anthracite Grey Smooth / White	2	White	Anth#/White	7016/9010
Basalt Grey	1	White	Bslt	7012
Beck Brown	1	White	Bck	8022
Beck Brown	2	Brown	Bck	8022
Chartwell Green	1	White	CGrn	-
Cream	1	White	Crem	9001
Cream	2	White	Crem	9001
Golden Oak	1	White	GOak	8001
Golden Oak	2	Caramel*	GOak	8001
Irish Oak	1	White	IOak	1011
Irish Oak	2	Caramel*	IOak	1011
Pebble Grey	1	White	Pbbl	7032
Pebble Grey/White	2	White	Pbbl/White	7032/9010
Rosewood	1	White	Rose	8015
Rosewood	2	Brown	Rose	8015
Silver Grey	1	White	Silv	7001
Slate Grey	1	White	Site	7015
White	1	White	White	9010
White	2	White	White	9010

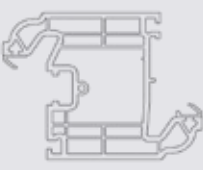
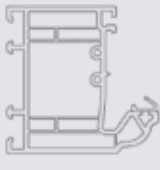
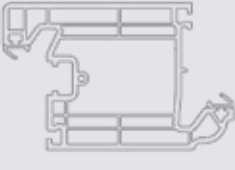
*Caramel base will be discontinued on all products from September 2020. From June 2020 Brown stock will be available to enable a smooth transition from Caramel.

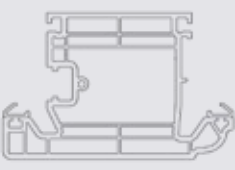

Combining the authenticity of a traditional window with the modern performance benefits of PVCu, Rustique offers the ultimate solution for when aesthetics and performance are demanded.

Expertly extruded, the 70mm system is multi-chambered with steel reinforcement to optimise performance, security and thermal efficiency. The suite can also be integrated with the System 10 70mm bevelled edged system for versatility.

<p>705543 95mm T Mullion / Slim Door Sash Open Out</p>		<p>701531 56mm Outerframe</p>	
<p>705545 95mm Z Mullion / Slim Door Sash Open In</p>		<p>701532 72mm Outerframe</p>	
<p>705540 Door Sash Open In</p>		<p>702533 70mm T Transom</p>	
<p>705541 Door Sash Open Out</p>		<p>702535 116mm Midrail</p>	
<p>703539 Tilt & Turn Sash</p>		<p>702536 70mm Z Transom</p>	
<p>702612 French Overlap</p>		<p>703538 Internally Beaded Sash</p>	
<p>707431 28mm Sculptured Glazing Bead</p>			



Colour	Sides	Base	Ref	RAL Colour
Agate Grey	1	White	Agte	7038
Agate Grey	2	White	Agte	7038
Agate Grey / White	2	White	Agte/White	7038/9010
Anthracite Grey	1	White	Anth	7016
Anthracite Grey	2	White	Anth	7016
Anthracite Grey / White	2	White	Anth/White	7016/9010
Anthracite Grey Smooth	1	White	Anth#	7016
Anthracite Grey Smooth	2	White	Anth#	7016
Anthracite Grey Smooth / White	2	White	Anth#/White	7016/9010
Basalt Grey	1	White	Bslt	7012
Beck Brown	1	White	Bclk	8022
Beck Brown	2	Brown	Bclk	8022
Chartwell Green	1	White	CGrn	-
Cream	1	White	Crem	9001
Cream	2	White	Crem	9001
Golden Oak	1	White	GOak	8001
Golden Oak	2	Caramel*	GOak	8001
Irish Oak	1	White	IOak	1011
Irish Oak	2	Caramel*	IOak	1011
Pebble Grey	1	White	Pbbl	7032
Pebble Grey/White	2	White	Pbbl/White	7032/9010
Rosewood	1	White	Rose	8015
Rosewood	2	Brown	Rose	8015
Silver Grey	1	White	Silv	7001
Slate Grey	1	White	Slte	7015
White	1	White	White	9010
White	2	White	White	9010

*Caramel base will be discontinued on all products from September 2020. From June 2020 Brown stock will be available to enable a smooth transition from Caramel.



A beautiful option when looking for traditional styling with modern PVCu performance, FlushSash sits true to the frame, offering the traditional understated elegance of timber.

Crafted using high specification VEKA or Halo profile, with a choice of mechanical or fully welded joints, FlushSash is as versatile as it is beautiful. It has a host of modern benefits including a multi-chamber internal construction for energy efficiency, robust security features and weatherproofing.

Halo Rustique

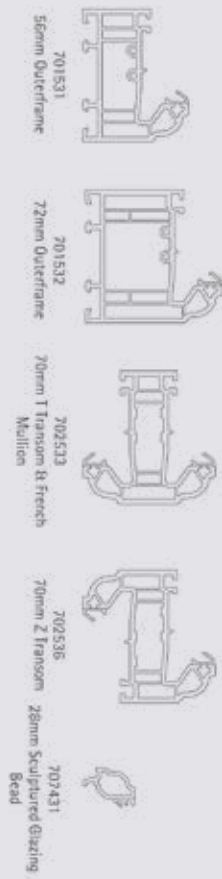

Halo System 10

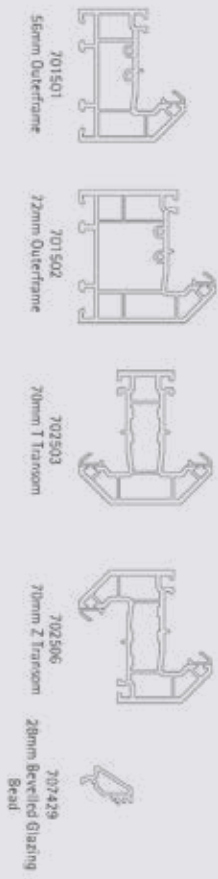

VEKA Matrix Fully Sculptured *



Common Profiles

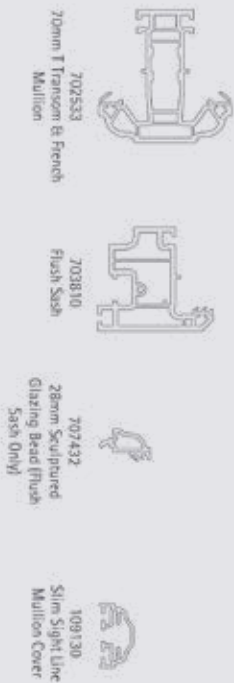
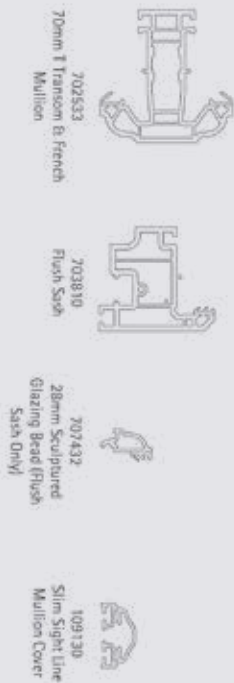
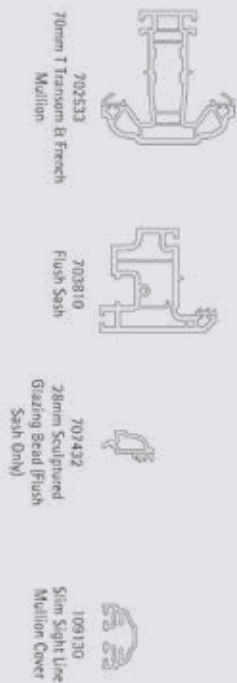

For ex-stock availability of the Rustique, System 10 and MFS systems, please refer to their specific availability chart within this brochure. These profiles are shown here as being compatible with the FlushSash profiles.

*Not available in Pebble Grey

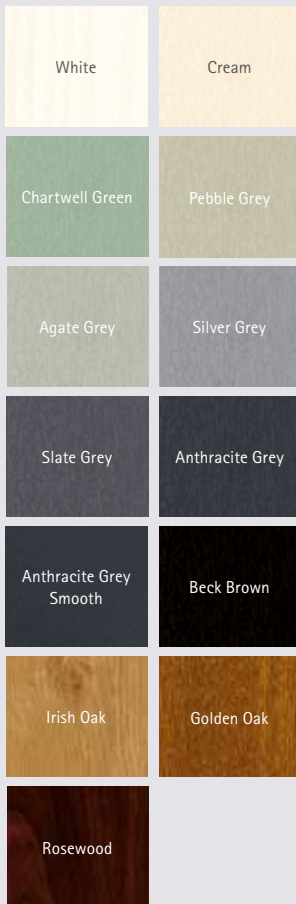

No MTO colour options available on Imagine VS**

Colour	Sides	Base	Ref	RAL Colour
Agate Grey	1	White	Agte	7038
Agate Grey	2	White	Agte	7038
Anthracite Grey	1	White	Anth	7016
Anthracite Grey	2	White	Anth	7016
Anthracite Grey Smooth	1	White	Anth#	7016
Beck Brown	1	White	Bck	8022
Chartwell Green	1	White	CGrn	-
Chartwell Green	2	White	CGrn	-
Cream	1	White	Crem	9001
Cream	2	White	Crem	9001
Golden Oak	1	White	GOak	8001
Golden Oak	2	Caramel*	GOak	8001
Irish Oak	1	White	IOak	1011
Pebble Grey	1	White	Pbbl	7032
Pebble Grey/White	2	White	Pbbl/White	7032/9010
Rosewood	1	White	Rose	8015
Rosewood	2	Brown	Rose	8015
Silver Grey	1	White	Silv	7001
Slate Grey	1	White	Slte	7015
White	1	White	White	9010
White	2	White	White	9010

*Caramel base will be discontinued on all products from September 2020. From June 2020 Brown stock will be available to enable a smooth transition from Caramel.

**Ex-stock colour combinations are those shown on the chart, any other combination is classed as MTO and is not available on this product.



The Imagine Vertical Slider carries all the beauty of a design classic, combined with the latest industry thinking.

A host of impressive features not only add to its good looks, but also enhance the performance of the product, working together to create the most technically advanced Vertical Slider on the market. Ideal for heritage, contemporary or classic applications, the Imagine Vertical Slider is at the pinnacle of PVCu technology offering style, functionality, security and thermal efficiency in equal measure.

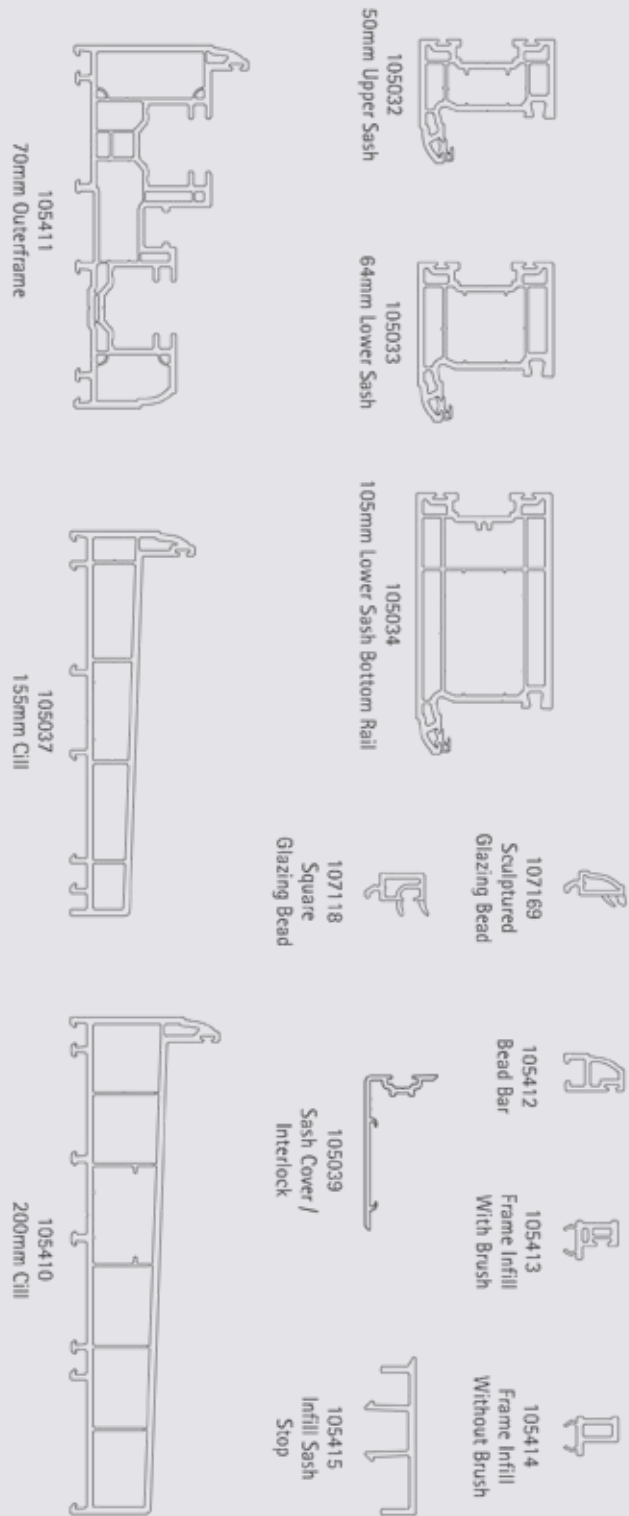



Fully Reversible | Ex-Stock Colour Availability

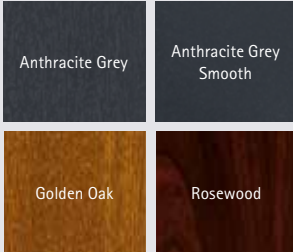

Colour	Sides	Base	Ref	RAL Colour
Anthracite Grey	1	White	Anth	7016
Anthracite Grey Smooth	1	White	Anth#	7016
Golden Oak	1	White	GOak	8001
Golden Oak	2	Caramel/Brown*	GOak	8001
Rosewood	1	White	Rose	8015
Rosewood	2	Brown	Rose	8015

*Caramel base will be discontinued on all products from September 2020. From June 2020 Brown stock will be available to enable a smooth transition from Caramel.







* VEKA = Caramel Base
Halo = Brown Base



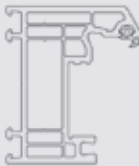

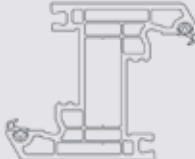



This fully integrated multi-chambered system includes steel reinforcement for superior quality, security and energy efficiency.

The VEKA Fully Reversible window has a contemporary bevelled rebate design whereas the Halo variant sits flush to the frame. Ideal for multi-story properties, the 180 degree reversible opening mechanism pivots within the axis of the hinge without protruding into the room to allow easy, safe and secure cleaning of the external glass from the inside of the property.

VEKA Fully Reversible

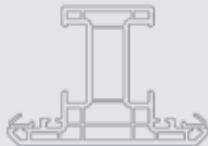
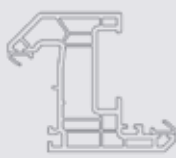
101164 60mm Outerframe	
103324 70mm Reversible Sash	
102269 86mm Z Mullion	
102268 86mm T Mullion	
102124 76mm False Mullion	
107168 28mm Bevelled Glazing Bead	

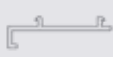
Halo Fully Reversible

701591 68mm Outerframe	
703592 68mm Reversible Sash	
702593 100mm T Transom	
703594 64mm Z Transom	
701501 56mm Outerframe	
709066 Weatherbar	
707431 28mm Sculptured Glazing Bead	
707429 28mm Bevelled Glazing Bead	

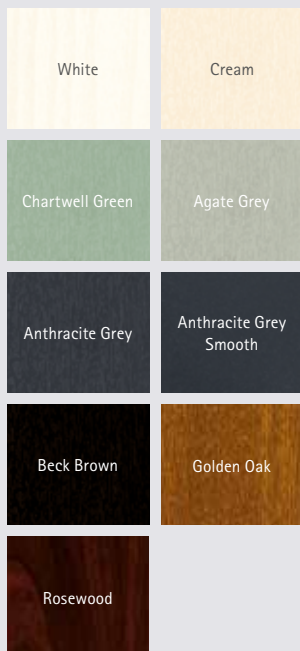

Colour	Sides	Base	Ref	RAL Colour
Agate Grey	1	White	Agte	7038
Anthracite Grey	1	White	Anth	7016
Anthracite Grey	2	White	Anth	7016
Anthracite Grey Smooth	1	White	Anth#	7016
Anthracite Grey Smooth	2	White	Anth#	7016
Beck Brown	1	White	Bck	8022
Chartwell Green	1	White	CGrn	-
Cream	1	White	Crem	9001
Golden Oak	1	White	GOak	8001
Golden Oak	2	Caramel*	GOak	8001
Rosewood	1	White	Rose	8015
Rosewood	2	Brown	Rose	8015
White	1	White	Whte	9010
White	2	White	Whte	9010

*Caramel base will be discontinued on all products from September 2020. From June 2020 Brown stock will be available to enable a smooth transition from Caramel.



This pioneering Imagine Bi-Fold Door offers elegant and understated aesthetics with a wealth of technical advancements for operational functionality, weather performance and security.

The Imagine Bi-Fold Door has a completely flush finish and a range of optional configurations allowing it to be tailored to any application.

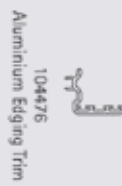
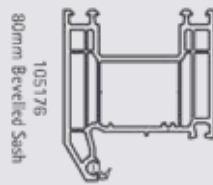
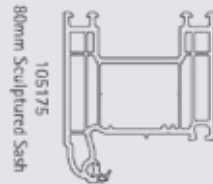
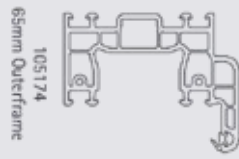

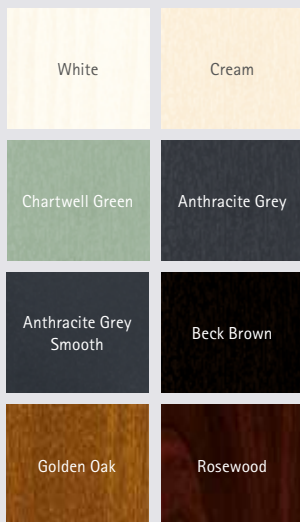









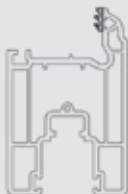

Colour	Sides	Base	Ref	RAL Colour
Anthracite Grey	1	White	Anth	7016
Anthracite Grey	2	White	Anth	7016
Anthracite Grey Smooth	1	White	Anth#	7016
Anthracite Grey Smooth	2	White	Anth#	7016
Beck Brown	1	White	Blek	8022
Chartwell Green	1	White	CGrn	-
Cream	1	White	Crem	9001
Cream	2	White	Crem	9001
Golden Oak	1	White	GOak	8001
Golden Oak	2	Caramel*	GOak	8001
Rosewood	1	White	Rose	8015
Rosewood	2	Brown	Rose	8015
White	2	White	Whte	9010

*Caramel base will be discontinued on all products from September 2020. From June 2020 Brown stock will be available to enable a smooth transition from Caramel.



The Imagine Patio Door offers stylish design together with a host of technical features for advanced functionality, security and performance.

The Imagine Patio Door is available with a choice of bevelled or sculptured sashes and a range of optional configurations, allowing it to be tailored to any application.

								
	105178 58mm Patio Outerframe							
								
	705151 Patio Sash Bevelled							
								
	702152 Patio Midrail Bevelled							
								
	703251 Patio Sash Sculptured							
								
	705252 Patio Midrail Sculptured							
								
	707427 28mm Bevelled Glazing Bead							
								
	707432 28mm Sculptured Glazing Bead							
								
	707426 32mm Bevelled Glazing Bead							
								
	109064 Draught Strip							
								
	704181 Interlock (3 Variants)							
								
	705152 Outerframe Cover							
								
	709112 Sash Cover							



Composite Door | Ex-Stock Colour Availability

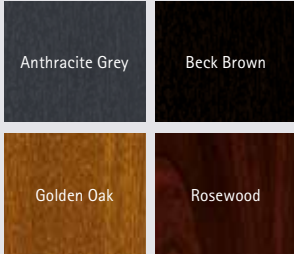

Colour	Sides	Base	Ref	RAL Colour
Anthracite Grey	1	White	Anth	7016
Beck Brown	1	White	Bck	8022
Golden Oak	1	White	GOak	8001
Rosewood	1	White	Rose	8015
Rosewood	2	Brown	Rose	8015



The VEKA composite door profile is suitable for use with standard composite door slabs.

Available in both bevelled and sculptured finishes, the multi-chamber PVCu door frames are expertly extruded for industry leading thermal efficiency, weather performance and security.

VEKA Composite Door

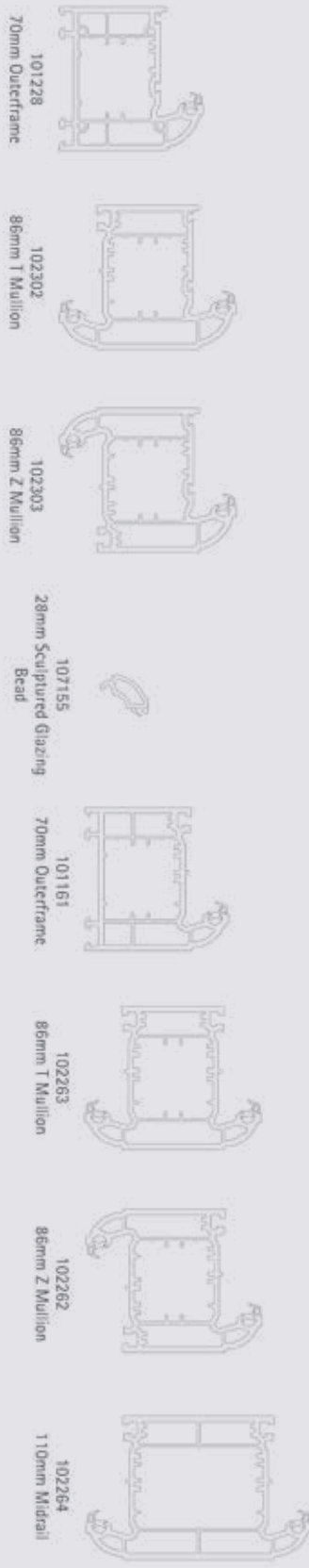

Halo Composite Door

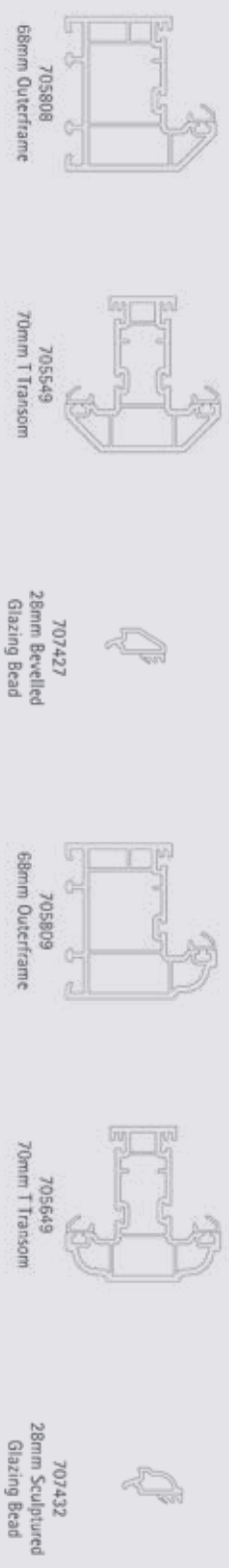



Colour	Sides	Ref	RAL Colour
Agate Grey	1	Agte	7038
Agate Grey	2	Agte	7038
Agate Grey / White	2	Agte/Whte	7038/9010
Anthracite Grey	1	Anth	7016
Anthracite Grey	2	Anth	7016
Anthracite Grey / White	2	Anth/Whte	7016/9010
Anthracite Grey Smooth	1	Anth#	7016
Anthracite Grey Smooth	2	Anth#	7016
Anthracite Grey Smooth / White	2	Anth#/Whte	7016/9010
Basalt Grey	1	Bslt	7012
Beck Brown	1	Blck	8022
Beck Brown	2	Blck	8022
Chartwell Green	1	CGrn	-
Cream	1	Crem	9001
Cream	2	Crem	9001
Golden Oak	1	GOak	8001
Golden Oak	2	GOak	8001
Irish Oak	1	IOak	1011
Irish Oak	2	IOak	1011
Pebble Grey	1	Pbbl	7032
Pebble Grey/White	2	Pbbl/Whte	7032/9010
Rosewood	1	Rose	8015
Rosewood	2	Rose	8015
Silver Grey	1	Silv	7001
Slate Grey	1	Slte	7015
White	1	Whte	9010
White	2	Whte	9010



We offer a wide range of ancillaries that can be laminated to match your profile colour perfectly.

From coupling covers, to cill end caps, to frame extensions and more, our comprehensive range of laminated mouldings is fully compatible with all Halo profile systems, providing the perfect professional finish to any installation.

HALO

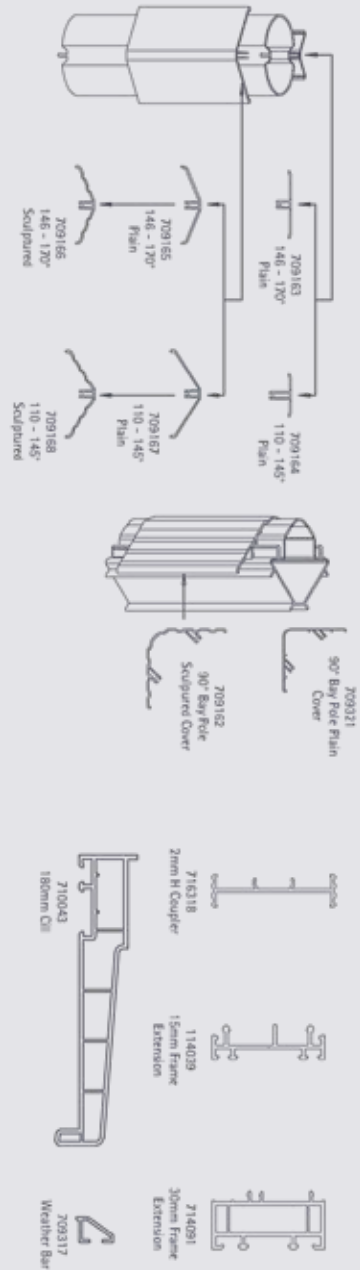

VEKA

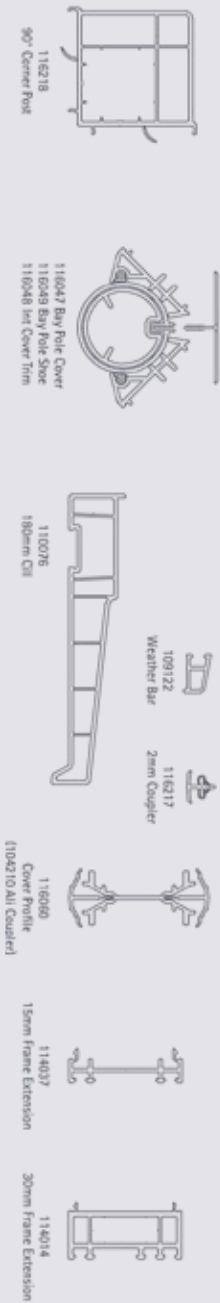

COMMON

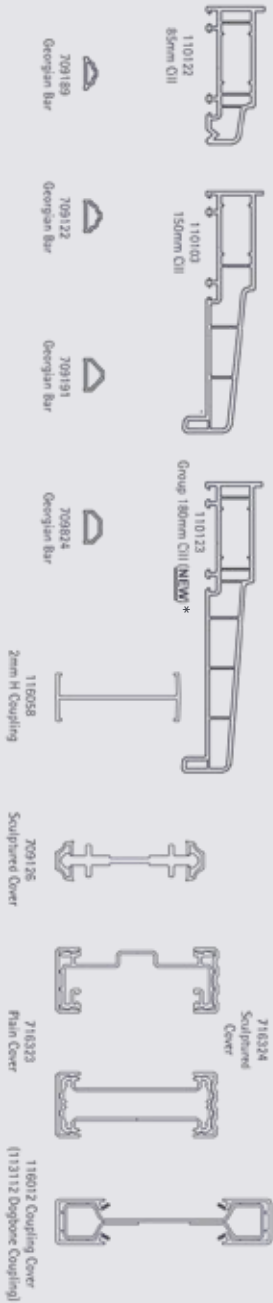

*110123 Available April 2020

Reinforcement guidelines

The following guidelines are based on using galvanised steel reinforcements which are supplied/specified by VEKA for guarantee purposes. Third party reinforcements are not covered by VEKA UK Kitemark certification.

Light Colour Specification

The following colours can be reinforced as per standard white windows. Please refer to the relevant technical manual for reinforcement and installation guidelines on domestic specifications.

Agate Grey

Chartwell Green

Cream

Irish Oak

Pebble Grey

Silver Grey

White

Dark Colour Specification

The remaining foil colours listed here should be treated as dark colour/woodgrain and reinforced/installed accordingly. Please refer to the relevant technical manuals for the correct specifications.

Anthracite Grey

Anthracite Grey Smooth

Basalt Grey

Beck Brown

Golden Oak

Rosewood

Slate Grey

Notes

RAL Colours	Guarantee Notes	Chemical Resistance	Maintenance
<p>The RAL colour references shown in this document and swatch book are shown as the nearest match to that particular foil and as such will not be an exact match. Please agree any colour match with your customers / paint suppliers prior to use.</p>	<p>Guarantee is ten years for all colours for the UK and Rol only. Please contact the VEKA UK customer services department for guarantee periods for supply into other countries. Guarantee periods cover the performance of the foil in terms of its weatherability and colour fastness. The guarantee period as indicated above will become void if the foil is over painted (due to solvents / chemicals found within the paint attacking the acrylic top layer of the foil).</p>	<p>Laminate foils are resistant to normal household cleaning agents e.g. ammonia water, aliphatic benzene, light alcoholic-water solutions, cleaning agents (non-abrasive), water and building materials e.g. cement, gypsum. Laminate foils are not resistant to any other organic solvents, mixtures of organic solvents and preparations containing organic solvents e.g. varnish thinners, varnish removers, polish and adhesives.</p>	<p>Appropriate cleaning with a damp soft cloth using mild detergents, excluding abrasive products. No further maintenance is required for the PVCu.</p>

Notes

A series of horizontal dotted lines for writing notes, spanning most of the page width.



VEKA plc

Farrington Road
Rossendale Road Ind. Est.
Burnley, Lancashire
BB11 5DA

Tel: 01282 716611
Fax: 01282 725257
salesenquiry@veka.com
www.veka.co.uk

Images are for illustration purpose only. We reserve the right to change product specification at any time.
Due to the limitations of the printing process we recommend that an accurate colour swatch is requested prior to ordering.
The company cannot accept any responsibility for colours or images shown in this brochure.
All information within this brochure is correct at time of going to print.

V02/20 | Company No. 01626563 | VAT No. GB 497951576



FOR NOW
FOR THE FUTURE
FOR LIFE